



# VANASTHALI GYANPEETH

Knowledge is The Best power

Diwali and Chhath Holiday H.W.

Month - November

Class : Nursery

Date : 10/11/2023

English

Name .....

Adm. No. ....

Roll No. ....

1. Match the capital letters with their small letters :-

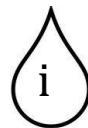
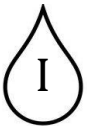
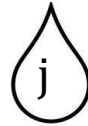
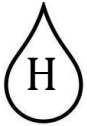
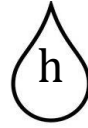

2. Write capital letters A to L

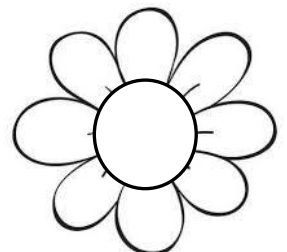
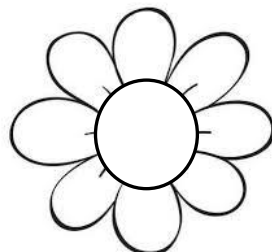
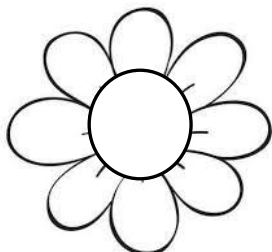
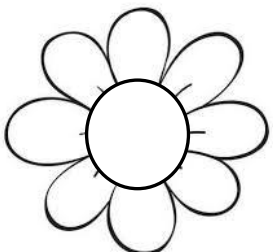
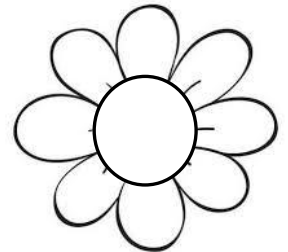
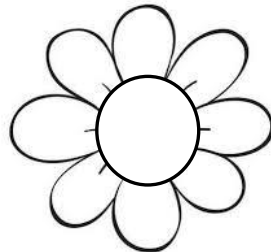
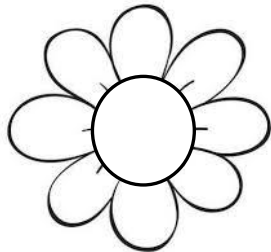
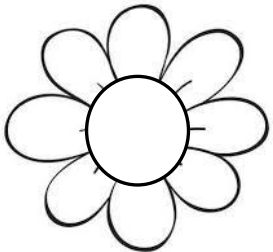
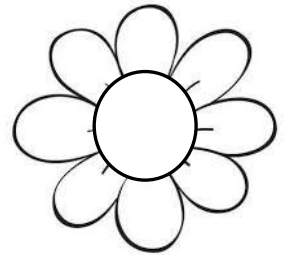
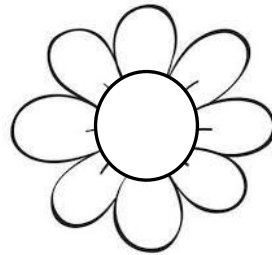
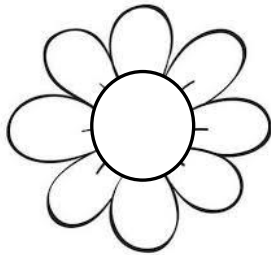
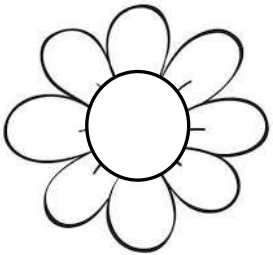

3. Circle the small letters (a to l) in the given picture.

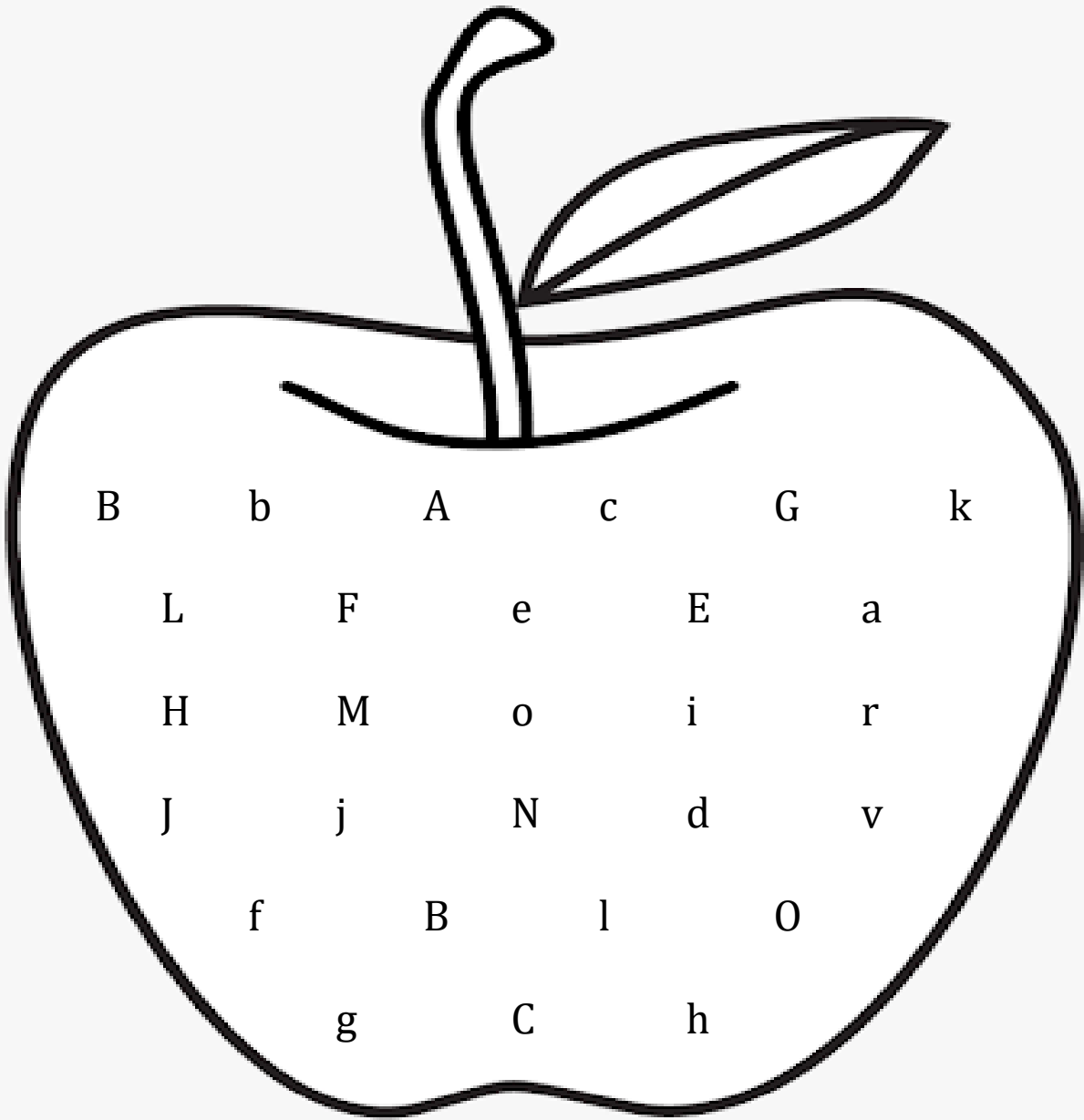

4. What Comes after?

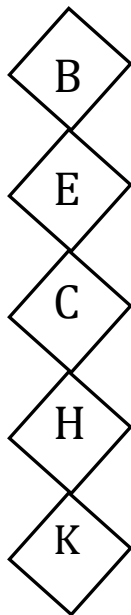

---

---

---

---

---

- English writing book (Capital and small letters) :- Do pg. no. 33 to 43.



# VANASTHALI GYANPEETH

Knowledge is The Best power

Diwali and Chhath Holiday H.W.

Month - November

Class : Nursery

Date : 10/11/2023

Hindi

Name .....

Adm. No. ....

Roll No. ....

1. पहले आने वाले वर्ण लिखें।



2. चित्र के नाम के शुरू में आने वाले अक्षर पर गोला लगाइए :-

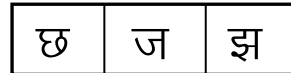
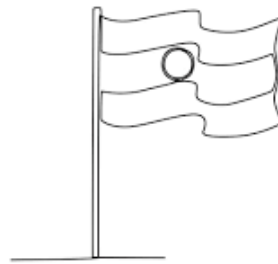
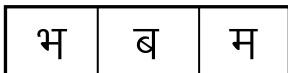
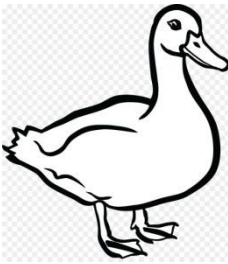
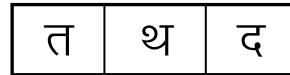
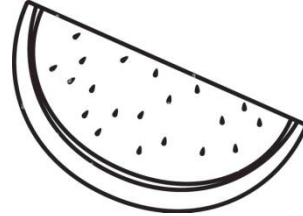
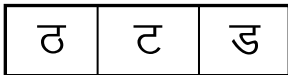
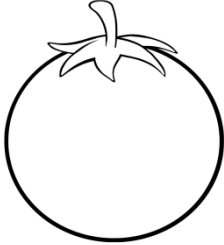

3. चित्रों के नाम के शुरू में आने वाला अक्षर लिखिए –

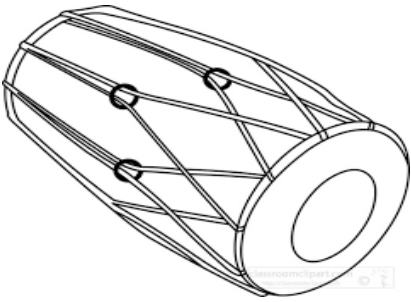
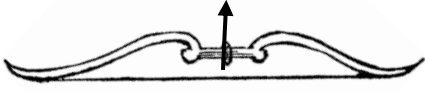

4. ट से न तक लिखें।

• Hindi Writing book (अक्षर सुलेख) %& Do pg. no. – 64 to 75

• Drawing book :- Do pg. no. – 27 to 30.



# VANASTHALI GYANPEETH

Knowledge is The Best power

Class : Nursery

Diwali and Chhath Holiday H.W.

Month - November

Date : 10/11/2023

Maths

Name .....

Adm. No. ....

Roll No. ....

1. Circle the smallest numbers :-

(a)

6	7	9
---	---	---

(b)

25	35	15
----	----	----

(c)

19	69	49
----	----	----

(d)

30	40	70
----	----	----

2. What comes before?

(a)  61

(b)  32

(c)  68

(d)  30

3. Write the missing numbers :-

(a) 21   24  26    30

(b)  42 43   46  48

(c) 61 62  64   67   70

4. Count and write the numbers

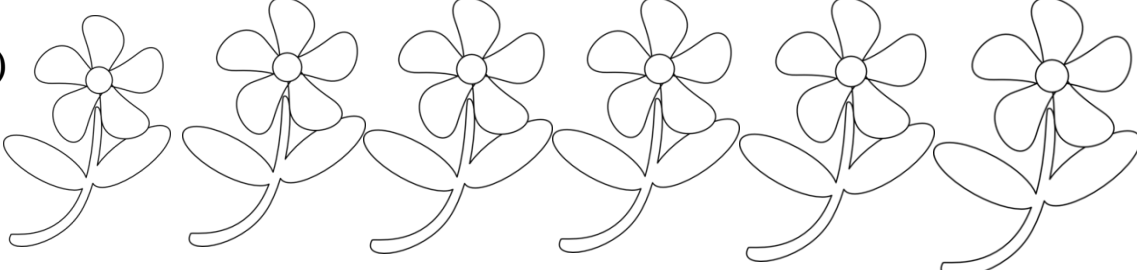
(a)  =

(b)  =

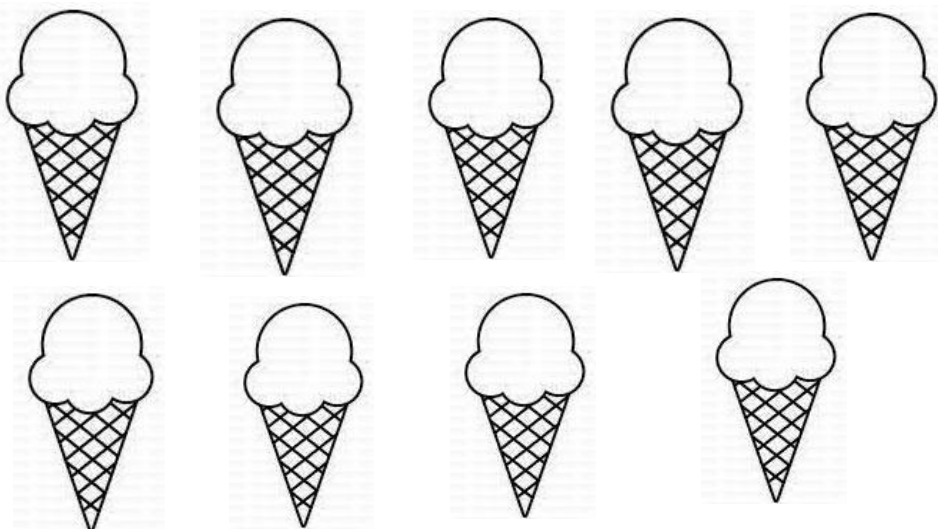
(c)  =

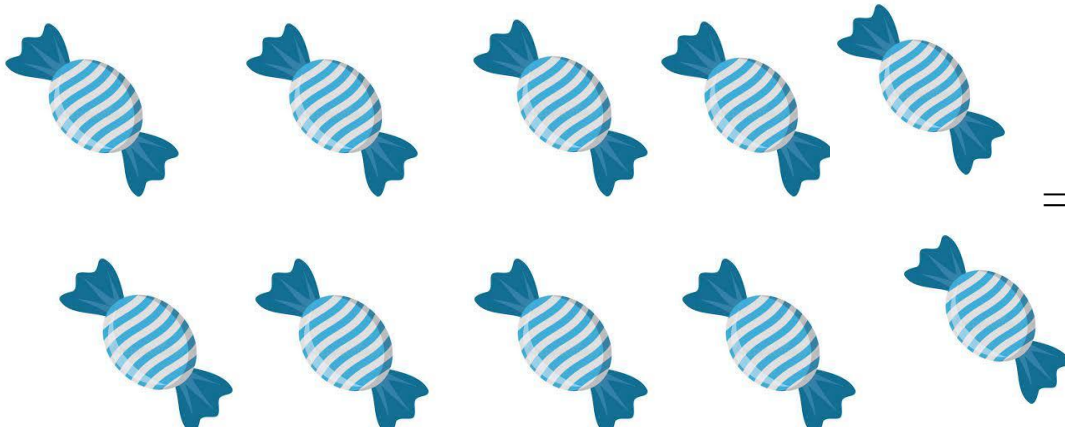
(d)  =